

F. Ternoy, J. Dandois, F. David,
M. Pruvost
(Onera)

E-mail: frederic.ternoy@onera.fr

Overview of Onera Actuators for Active Flow Control

The purpose of this paper is to present an overview of existing actuators at Onera for active flow control. These actuators are used for various applications in wind tunnel tests, from 2D models to half-wing and helicopter models, for external or internal aerodynamics subjects.

Depending on the available volume in the models and on the aerodynamic requirements in terms of actuation magnitude and bandwidth from subsonic to transonic conditions, various technical solutions have been retained.

There are many ways to classify actuators between mechanical/fluidic, zero-net-mass-flux/nonzero mass flux/plasma, etc. The first part of this paper is devoted to mechanical actuators (moving aileron, mini trailing edge devices and deployable vortex generators). Fluidic actuators are presented in the second part, which deals with pulsed fluidic vortex generators, pulsed blowing slots and synthetic jets. The third part is focused on the characterization of the fluidic actuators.

Introduction

The field of flow control has witnessed an explosive growth of the number of publications over the last twenty years. It is now a well-accepted fact that flow control is a key technology to improve aerodynamic performance beyond actual aerodynamic design. To actively control the flow around an aircraft or a rotorcraft, one necessarily needs efficient actuators compact enough to be integrated inside the vehicle, taking into account the structural aspects. There are numerous types of actuators in the active flow control literature, but the most popular ones, and this is not an exhaustive list, are the pulsed blowing actuators [1], the zero-net-mass flux actuators [2], the plasma [3,4], the combustion driven device [5], the sparkjets [6-8], the vibrating flaps [9-11], the Hartman tube [12-15] and the fluidic oscillators also called sweeping jets [16]. A review of existing actuators for active flow control can be found in ref. [17] and [18]. The purpose of this paper is to present an overview of existing actuators at Onera for active flow control.

Tools for flow control ...

Studies dealing with load control or flow control carried out by the actors of aeronautical research has led for many years to experiments on scaled wind tunnel models. By definition, these demonstrators are in general equipped with integrated actuators, controllable remotely and whose characteristics depend on the physical phenomenon to

be controlled. There is a tremendous amount of types of actuators in the active flow control literature, and they can be classified in various ways. One possible classification is to organize them as mechanical and fluidic actuators.

Mechanical actuators are aimed at modifying the shape of a vehicle, so as to act directly on its aerodynamic coefficients. They can be devices allowing the control of components, such as an aileron or a mechanical vortex generator, or systems able to deform the wing locally in an elastic way, for example to modify the twist of a wing.

Fluidic actuators modify the main flow around the vehicle by injecting a secondary flow on its surface. It is, in this case, the interaction of this secondary flow with the main flow that leads to a modification of the aerodynamic performance of the vehicle.

... and simulation devices

For simple cases, commercial off-the-shelf devices are directly usable in the wind tunnel models, without modification, or after minor adaptations. However, it is clear that many studies require complex solutions to be implemented, often starting from existing technological bricks, in terms of control, motorization or regarding the kinematics of the devices. A strong constraint in the specifications of such actuators is the compatibility with the volume available in the model, taking into account, not only the vehicle shape, of course, but also

the constraints related to safety criteria, in terms of mechanical resistance or of the integrated services and the problems of accessibility to these elements. When the physical principle to be simulated by the actuator already led to the realization of “large scale” actuators, the passage on the small scale model, with the respect of the similarity rules, generally means the review of the existing design from zero.

Today, in most cases, numerical simulations allow the evolution of all flow variables to be followed, including those inside the fluidic actuators. Nevertheless, it is necessary to validate these unsteady numerical simulations with flow and load control, with the experimental approach using such advanced actuators. These tests allow the phenomena to be investigated taking into account all of the fluid physics parameters.

The aim of these studies being the fine characterization of the phenomena, precision on the actuators (geometry, position, output velocity, signal shape, etc.) remains essential.

Mechanical actuators

Largely used on commercial aircraft, this type of actuator is naturally the subject of many developments within the framework of industrial model projects for wind tunnel tests. In most cases, their only purpose is to increase the test productivity, by avoiding any human operation on the models at each configuration change. However, some studies on aerodynamic control are interested in an unusual operation of known control surfaces, or in the integration of completely innovative control surfaces. It is in this case requested to design, manufacture and develop adapted motorizations.

Remote controlled aileron by hydraulic system

Context

Within the framework of the French program “DTP Modèles 3” (see ref. [19] for more details), which is aimed at validating numerical methods for aircraft configurations featuring control surfaces, the goal is to design, manufacture and operate an actuator that allows a remotely controlled aileron to be integrated into a modern half-wing model, to be tested under transonic conditions (figure 1). The actuator must be compatible with high loads at high frequencies.



Figure 1 - DTP Modèles 3 – half-model in the S2MA wind tunnel (left) and detailed view of the R/C aileron (right)

The approximate dimensions of the aileron are 47 mm mean chord and 256 mm span, and the requirements in terms of displacements and efforts to sustain are:

- Static characteristics:
 - Positioning to static positions in the range $[-15^\circ; +15^\circ]$;
 - Operational over the whole total pressure range $[0.5; 1.9 \text{ bars}]$;
 - Operational over the whole Mach number range $[0.70; 0.89]$;
 - Operational up to the maximum lift coefficient;
- Dynamic characteristics:
 - Total pressure 0.5 bar (for pure aerodynamic purposes);
 - Unsteady aileron setting around an aileron average setting (sinusoidal type or step);
 - Average aileron setting in the range $[-12^\circ; +12^\circ]$;
 - Dynamic movements up to 200 Hz;
 - Movement amplitude from $\pm 1^\circ$ (200 Hz) to $\pm 3^\circ$ (lower frequencies).

Technical solution

Due to the magnitude of the loads on the aileron (12 Nm maximum hinge moment), a hydraulic servo valve is used to provide the necessary power. The hydraulic pressure is driven to the aileron through the wing span in a cavity shared with the instrumentation wires (figure 2).

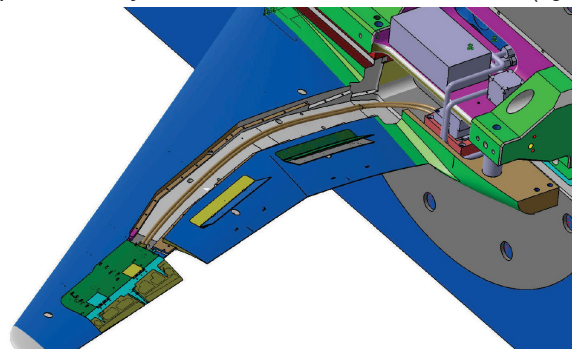

Figure 2 - Hydraulic pipes inside the wing main cavity

An innovative mechanical system is developed to transmit the movement to the aileron in the limited volume available in the aileron region. The solution is based on a multi-cylinder hydraulic system. Each cylinder pushes a stinger attached to the aileron at a certain distance from the aileron hinge, to allow for rotation. One stinger is equipped with a LVDT (Linear Variable Differential Transformer) sensor used as control sensor in the closed loop system. A second LVDT sensor is installed in the root area of the aileron and allows the surface deflection to be measured directly on the part. The aileron motorization is designed as a separate device, so that it is possible to test it first on a bench before integration into the wing.

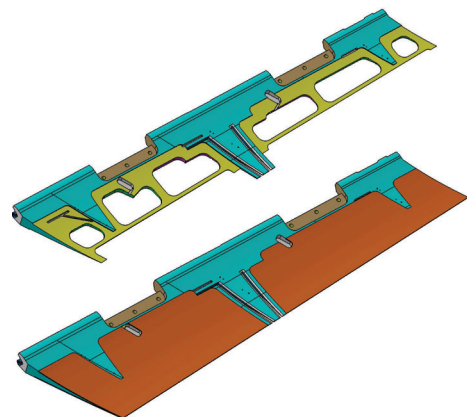

Figure 3 - CAD view of the aileron structure (above: without external composite skin)

The design takes into account the wing's deflection under aerodynamic loads, which is estimated by FEM analysis so that the behavior of the actuator is not modified because of the bending of the model. The aileron structure (steel structure and carbon skins) is a compromise between robustness, moment of inertia and internal stress, resulting in a surface with low deformation distortion over its span. To reduce its stiffness, the structure of the aileron is partially split over its chord following a « V » shape slots filled with adhesive silicon (figure 3).

Characterization

During the design phase, the response of the system is estimated analytically. Since the functioning with several cylinders in parallel is innovative and challenging, several tests are performed on the system to identify and adjust its response over the complete amplitude and frequency domain. The closed loop control is tuned by the analysis of successive Black diagrams, obtained with frequency sweeps between 10 Hz and 200 Hz. The response of the system is improved by using two electronic correctors.

Tests are first performed on a bench. For these tests, the aileron is replaced by a simple part, identical in terms of inertia. Three frequency cases are tested (figure 4). The system response to a step is also tested (figure 4d). The aileron position accuracy is improved by using an additional high frequency signal on the main input, which reduces the threshold effect of the servo valve. A loading test is also performed to check the stiffness of the system.

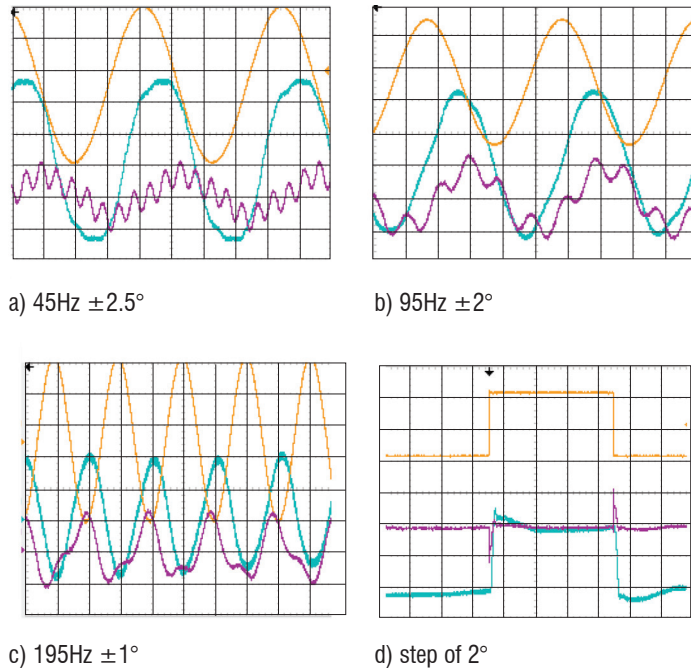
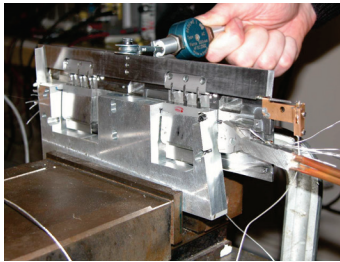

Figure 4 - Test bench (top) and response measurement for 4 cases (yellow: input signal - purple: input corrected with additional high frequency signal - blue: control sensor)

A second run of tests is performed after actuator integration into the wing and before the wind tunnel entry. The position of the aileron is recorded through the inner sensor and 2 Keyence systems located at the inner and outer part of the aileron (figure 5).

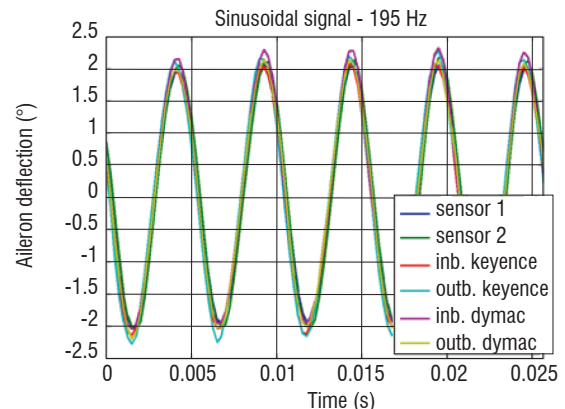
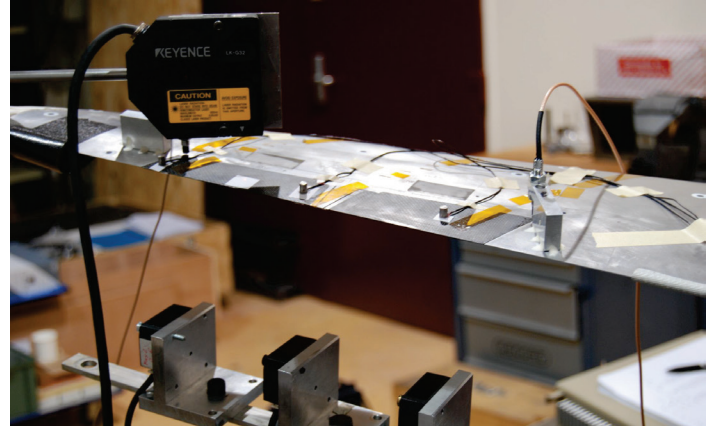

Figure 5 - Integrated actuator and final response analysis

Remote controlled piezoelectric mini trailing edge vices

Context

This study was performed within the EC funded AWIATOR project managed by Airbus (see ref. [20] for more details). The aim is to test technologies applicable to future airliners and to study new control surfaces that could improve the wing performances during takeoff and landing operations.

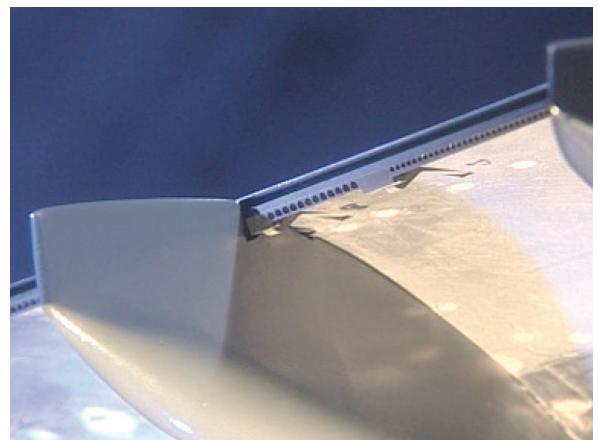

Figure 6 - Detailed view of the RC mini-TEDs (close-up view of the trailing edge on the lower side)

The work carried out by Onera consists in integrating a trailing edge equipped with mini-deflectors into the wing of an existing A340 1/19th scaled model. These mini-deflectors, called “minis-TEDs” (mini Trailing Edge Devices), whose chord is equal to 5mm, are controlled in frequency and amplitude. The bandwidth is 180 Hz for an amplitude of 10°. Electronic control allows piloting the deflectors using sinusoidal or step laws.

Technical solution

Contrary to the previous hydraulic actuator, the lower aerodynamic loads allow the use of a piezoelectric motorization. The model has 2 movable surfaces (mini trailing edge devices with a chord length equal to 2% of the profile) actuated by the piezoelectric actuator via a kinematics based on a lever and rod devices. The actuator is an amplified piezoelectric actuator designed especially for this model (dimensions: 10*49*141mm – max displacement: 0.5mm – max force: 700N).

This piezoelectric actuator has very short displacement amplitude, so it is necessary to amplify it to obtain a significant movement of the TED by using lever and rods integrated inside of the model. The kinematics converts the translation into a rotation of about 60° for the TED. The proposed design allows the relative angle of the 2 mini-TEDs to be adjusted accurately.

All of the articulations of the mechanism are obtained with “joint blades” to avoid any gaps that would lead to problem for the dynamical response of the system. Each part of this mechanism is optimized, in terms of mass and mechanical resistance, in order to obtain the specified bandwidth.

The joints, between mini-TEDs and rods on the one hand and between mini-TEDs and wing on the other hand, are obtained with very accurate shafts and bores, in order to decrease the mechanism gaps as much as possible.

Characterization

The mechanism is driven by an electronic control system. There are 4 position sensors installed in the mechanism: the first one measures the lever displacement, two sensors on outboard TED measure the angular position of the outboard TED via specific measurement rods and the last one directly measures the angular position of the inboard TED.

As for the dynamic aileron case, the response of the system is estimated analytically. The closed loop control is tuned by analysis of successive Black diagrams obtained with frequency sweeps between 10 Hz and 200 Hz. To make this actuator compatible with the specifications, the response of the system is improved by using two electronic correctors and adjustments are done following the results of lab tests performed first on bench.

Deployable mechanical VGs

Context

Helicopter rotor blades encounter a wide range of aerodynamic conditions during cruise flight, varying from transonic flow, with moderate

angles of attack on the advancing blade side, to low subsonic flow with large angles of attack on the retreating blade side. With increasing cruise speed, angles of attack above static stall are reached on the retreating blade side. The cyclic pitching motion of the blade then leads to dynamic stall that induces large unsteady loads. In particular, large negative (nosedown) pitching moments are observed during dynamic stall and induce large impulsive pitch-link loads that can damage the control command of the helicopter. Dynamic stall may appear under several flight conditions, such as high-speed forward flight or maneuvers, and it strongly limits the flight envelope of the rotorcraft. The pitching moment alleviation of the dynamic stall will lead to an extension of the flight envelope, by reducing the unsteady loads on the blade, limiting the blade aeroelastic response and decreasing the vibratory loads for high-speed forward flight. Therefore, dynamic stall-related topics have been studied, in order to improve the understanding of the complex physical phenomena involved when the flow separates during the pitching motion of the blade. Dynamic stall control using dedicated actuated devices has also been studied. This was the main goal of the Onera-DLR “SIMCOS” research project (see ref. [21] for more details). In this project, the pitching moment is reduced by generating vortices with numerous (120) small blades located at the very leading-edge of a bi-dimensional “OA209” airfoil model.

Technical solution

These blades are spaced by 11.5 mm and oriented on an angle of 18 degrees with respect to the freestream (figure 7 and figure 8). With this orientation, each blade produces a vortex that will expand along the upper surface of the airfoil.

In order to reduce the pitching moment while avoiding drag and lift penalties outside the aerodynamic stall conditions, an active device is designed and, at the same time, the blades fit the airfoil leading-edge shape so that, when retracted, the airfoil is clean. The blades, named “DVGs” (Deployable Vortex Generators) are displaced with a forward-backward translation motion.

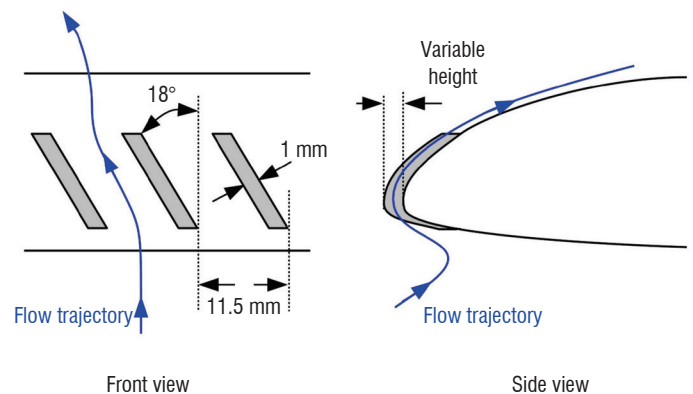

Figure 7 - Sketch of the vortex generator system



Figure 8 - Leading edge of the wind tunnel model

Facing the required amplitude (up to 3 mm), the control motion system makes use of two hydraulic jacks located in the airfoil body. The blades are fitted to the control system with the aid of a transverse carbon fiber bar, which goes through each blade heel (figure 9).

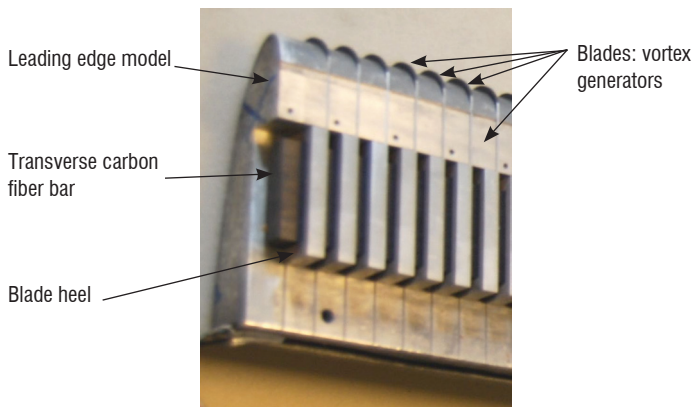

Figure 9 - Bottom view of the leading edge without its lower surface

A Teflon treatment is applied on each DVG, in order to limit frictions during the deployment. The clearance between the DVG, the model and the bar, is judiciously applied in order to insure the functioning and the control even with the model distortion caused by aerodynamic loads.

The test campaign has shown the efficiency of such a device and also shown that the size, the density and the maximum displacement of the blades should be reduced, with up to 55% reduction of the negative pitching-moment peak for height displacements between 1.5mm and 1.7mm [21], offering the possibility of using a more compact motion control system, like a piezo-hydraulic system, for example.

The effect of VGs was also evaluated numerically, showing that thinner blades could be more efficient (see ref. [22] for more details).

Actuator Characterization

Lab tests were performed and showed that the DVGs can be actuated at operational frequencies from 1-per-rev (approx. 3.5 Hz) to 10-per-rev (approx. 35Hz) for the full range of height deployment (3 mm), with a mean accuracy of 0.05mm (figure 10).

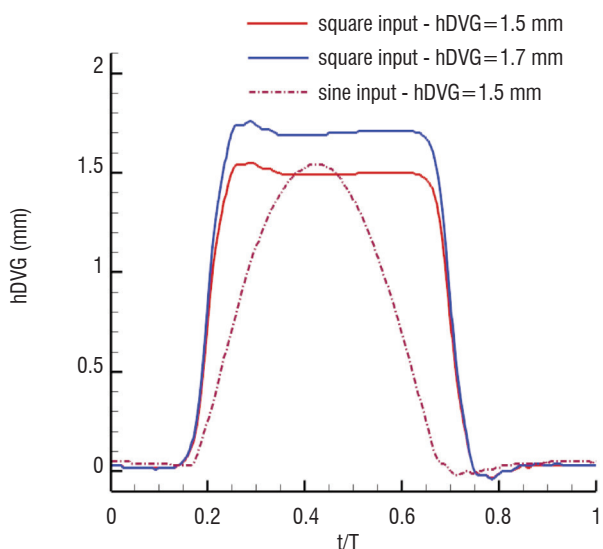

Figure 10 - Displacement response under square and sine excitations at 1 per-rev

The reliability of this simple device has been proven by a huge number of functioning hours (up to 150 functioning hours without control accuracy loss).

Fluidic actuators

In addition to the studies conducted on the mechanical actuators, the main current axis of research in the active flow control actuator community is the development of fluidic actuators. The goal is to address several external aerodynamics subjects (lift increase, drag reduction, buffet control) and internal aerodynamics ones (advanced air intakes). The development of these techniques and corresponding methods of CFD analysis requires wind tunnel tests. Two types of fluidic actuators are developed at Onera.

Pulsed blowing actuators are valves controlling the mass flow rate from an air feed whose characteristics (temperature and pressure) are generally fixed. These actuators can be used at various frequencies and duty cycles, the continuous blowing case being only a particular case where the forcing frequency is null. Today, many developments are made, not only by industrials specialized in the field of valves, but also by research institutes, to develop devices able to generate pulsed jets; however, the characteristics of these actuators remain limited. The main interests of the developed devices, compared with state of the art devices, are that they offer in a very small volume a high mass flow with the possibility to adjust it progressively for a large frequency bandwidth.

Synthetic jet actuators are different from the previous ones, due to the fact that they do not require any external air feeding. They work in the manner of syringes: the piston movement is alternate and a small quantity of fluid is successively sucked and expelled through an orifice, or a slot, in the main flow. Spark-jets which are not presented in this paper are a particular case of synthetic jets, for which the alternate fluid motion is obtained by a discharge from the cathode to the anode. The rapid gas heating generates an increase of the chamber pressure. Then, the high-pressure gas exhausts through the chamber orifice at high velocity. In the next stage, the initial conditions are recovered through the sucking of fresh air from the outside. For the synthetic jets actuator a brief analysis of the state of the art is given hereafter.

Such studies are at a very low Technology Readiness Level and also require the development of a suitable methodology, in order to characterize the gas jets in a fine way, and to make the wind tunnel test measurements exploitable.

Pulsed fluidic vortex generators

Context

Within the framework of the Onera internal project PRF BUFET'N CO [23,24], wind tunnel tests with fluidic actuators were carried out under transonic conditions. The objective of the project is the closed loop control of the buffet phenomenon to delay its onset on a wing. The reader interested in a summary of the results can refer to ref. [24] in the same volume of Aerospace Lab. One of the solutions tested is based on the use of pulsed fluidic vortex generators (VGs), requiring the development of specific actuators whose characteristics are the following:

- Orifice shape: circular section with diameter equal to 1mm;
- Fluidic VGs locations, spacing and blowing angles: located at 25% of chord, spacing equal to 10 diameters, pitch angle between the jets and the local wall tangent equal to 30° and skew angle between the jets and the freestream direction equal to 90°;
- Maximum Mach number (nozzles): Mach 2;
- Frequency bandwidth: 1 kHz;
- Maximum mass flow: 1 g.s⁻¹ per hole.

The wing in which these devices are integrated has a span equal to 1.2 m. It is based on the OAT15A profile with a chord length equal to 300 mm in the equipped area.

Technical solution

The actuator is composed of a tight case in which the active devices are placed. The jet exit holes are located in the inner top face. The external face receives an interchangeable cover (in green on figure 11) in which the nozzles are milled, making it possible to create the desired jets (form, speed, direction). The general principle consists in controlling a valve actuated by an actuator. The generator is composed of a series of cells, each comprising one actuator (figure 12). The active elements are piezoelectric stacks amplified mechanically. These actuators lengthen proportionally with the tension applied to them. With such active elements, the frequencies can be higher than 1,000 Hz and the ratio between the volume and the product force by displacement is particularly interesting (volume=500mm³ – max force*max displacement = 0.4N*mm). The stroke of the valve, which remains limited, is compensated by the length of the exit section, which is at its periphery.

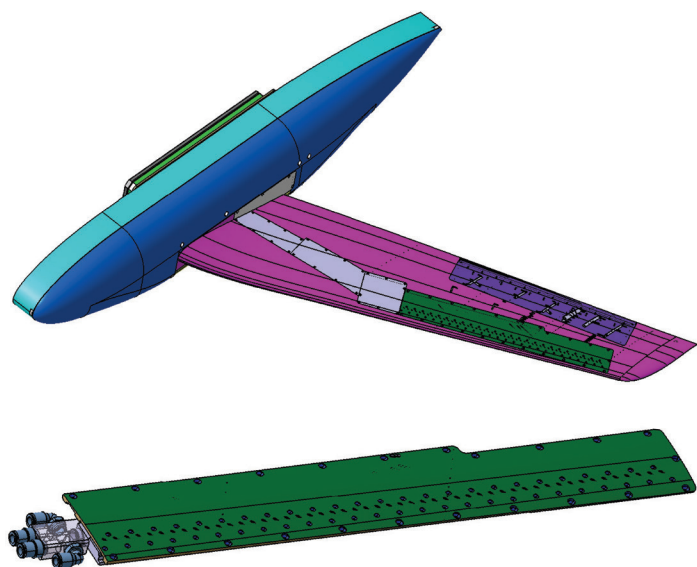

Figure 11 - CAD views of the model and the actuator clamped on its cover

To obtain a supersonic jet at the exit, it is necessary to have a high relative pressure. The maximum force that can be delivered by the piezoelectric actuator limits the diameter of the valve. Indeed, the latter is pressed on its seat when the valve is closed. The mechanical amplification system allows sufficient force to be kept available to move the valve under these conditions.

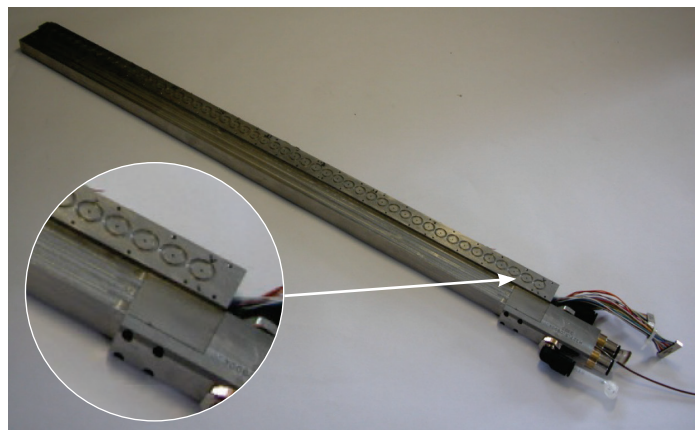

Figure 12 - Pulsed jet actuator (global view, left: detailed view of the orifices)

Actuator command and characterization

The actuator can be either controlled in an all-or-nothing way, or in a proportional way. In the case of a proportional valve opening, the command requires the use of an off-the-shelf commercial amplifier. If the actuator is used in an all-or-nothing way, the device having only two states (open or closed), a binary command of the actuators is sufficient and specific electronics are developed for the power supply. The actuators are either electrically fed or short-circuited. Since the electric behavior of these actuators is similar to a capacitance, the current becomes very important at high frequencies. Since the supply voltage is high also, the power needed can become very high. Depending on the operating time and the commutation frequency of the electronics, the protection resistances, as well as the cooling system, are dimensioned to limit the electronic temperature.

Visualizations by Schlieren photography are performed to check whether the jets are supersonic (figure 13). The mass flow measurements also allow the capacities of these actuators to be validated, to fulfill the specifications.



Figure 13 - Schlieren photography of the supersonic jets

Figure 14 shows the mean mass-flow for the 50 actuators with a sinusoidal excitation signal at various frequencies from 10 Hz to 700 Hz. It points out that the mean mass flow is rather uniform over the 50 actuators ($\sim 0.15 \text{ g.s}^{-1} \pm 0.03 \text{ g.s}^{-1}$ except for actuator number 8) and that the actuator response is rather flat over the entire frequency range [10 Hz; 700 Hz] ($\Delta \text{max} = 0.04 \text{ g.s}^{-1}$).

Figure 15 shows the excitation signal (in black) and the measured velocity by hot-wire for various frequencies between 100 Hz and 700 Hz at a supply pressure of 2.7 bars. The peak velocity decreases

from 320 m.s⁻¹ to 250 m.s⁻¹ when the forcing frequency increases but the shape of signal is well preserved and there is no leak at high frequencies as it is often observed for other actuators.

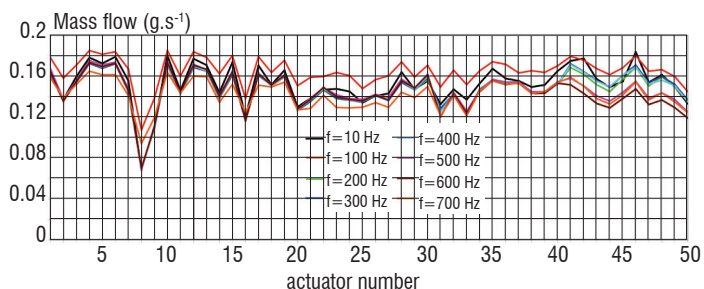

Figure 14 - Mean mass flow for the 50 actuators and a sinusoidal excitation signal at various frequencies

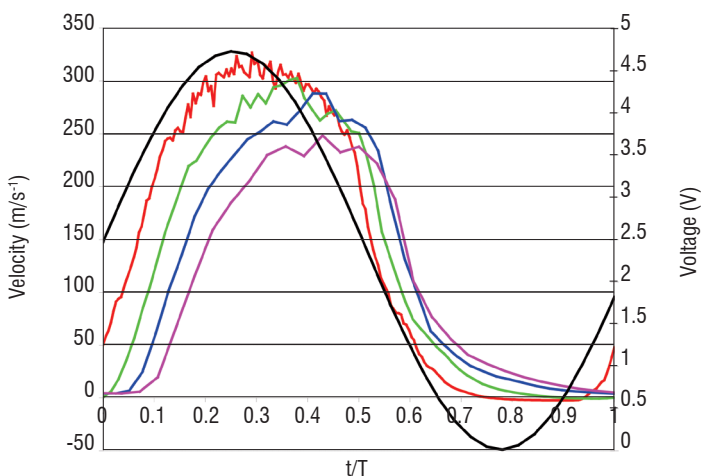

Figure 15 - Excitation voltage signal (in black) and hot-wire velocity signals for various frequencies at a supply pressure of 2.7 bars (red: 100 Hz, green: 300 Hz, blue: 500 Hz, purple: 700 Hz)

Pulsed blowing TED

Context

Within the project PRF BUFET'N CO, another kind of pulsed blowing actuator was integrated and tested on the wing described in the previous chapter. The reader interested in a summary of the results with this actuator can refer to ref. [24] in the same volume of Aerospace Lab. Specific tests were performed on fluidic TEDs (Trailing Edge Devices) whose characteristics are:

- Orifice dimensions: slot width equal to 0.2 mm and length equal to 490 mm in the spanwise direction (between 45% and 85% of the wing span);
- Slot location and orientation: located at 95% of the chord on the lower side of the model; normal blowing with respect to the local wall tangent;
- Frequency bandwidth: 200 Hz;
- Maximum mass flow: 140 g.s⁻¹ per meter span in this configuration.

Technical solution

The actuator is based on the same principle as that used for the pulsed vortex generators, adapted for large mass flow or large scaled model applications. Indeed, it meets specifications that are less restricting in terms of bandwidth and volume availability, but more restricting

concerning the high mass flow to produce. The actuator is installed in a large cavity in the model and feeds the slot via holes connected to a plenum integrated in the trailing edge of the model (figures 16 & 17).

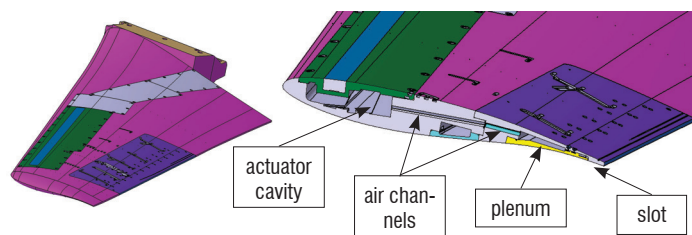

Figure 16 - CAD views of the model and section view of the air channel area

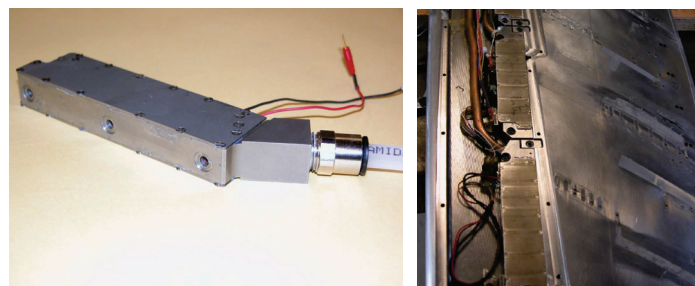

Figure 17 - actuator before integration (left) and integrated inside wing's main cavity (right)

The actuator employs piezoelectric stacks elements whose displacement is amplified mechanically by using kinematics based on steel joint blade articulations. The valve is made of aluminium to minimize its mass and reduce the response time of the system. To improve the behavior of the actuator at high frequencies, additional mechanical absorbers can be added between the valve and the tight case of the actuator. The air supply is connected directly onto the main body of the actuator. Its geometry is designed to ensure a good homogeneity between the 3 holes at the exit of the actuator.

Actuator command and characterization

As for the pulsed fluidic vortex generator, the actuator can be either controlled in an all or nothing way or in a proportional way, by using of a commercial amplifier or with a specific electronic developed for the power supply.

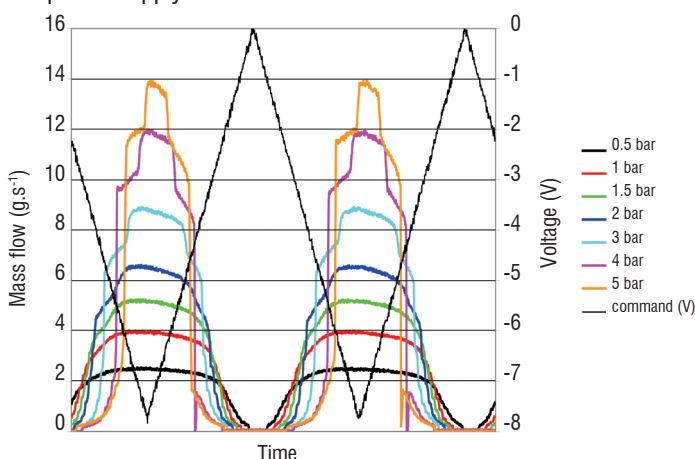

Figure 18 - Mass flow evolution vs. time for a triangular voltage signal and different air feeding pressure

Figure 18 shows the time evolution of the mass flow for a triangular voltage excitation and different air feeding relative pressure from 0.5

to 5 bars. It shows that it is possible to control the mass-flow in a proportional way and that the maximum mass flow is equal to $14 \text{ g}\cdot\text{s}^{-1}$ for a relative pressure of 5 bars, for 10 cm slots length in the span wise direction.

Application of active flow control at the leading edge

Within JTI Clean Sky Smart Fixed Wing Aircraft Integrated Technology Demonstrator (SFWA-ITD) European project, a study was made in order to evaluate how compact a valve should be to be compatible with the equipment of a scaled 1 business jet wing tip. This actuator was proposed for integration and the outcome is a representative insert equipped with a large scale valve which blows through a tangential slot with a width of 0.5 mm located at 1% of the local chord (figure 19). In this configuration, the actuator is able to generate a pulsed blowing of $200 \text{ g}\cdot\text{s}^{-1}$ per meter span at 200 Hz.

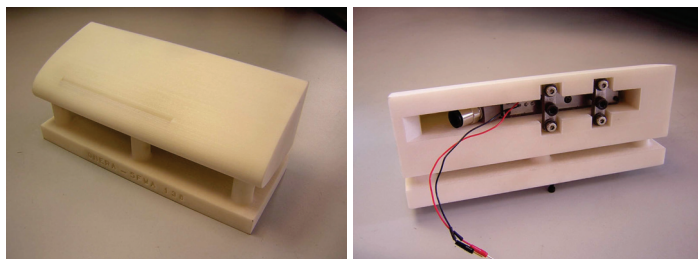

Figure 19 - Picture of the actuator integrated in a part representative of a scaled 1 wing tip

Synthetic jets by piezoelectric actuators

Context

Within the framework of the JTI Cleansky Smart Fixed Wing Aircraft (SFWA-ITD) and Green Rotorcraft Integrated Technology Demonstrator (GRC-ITD) European projects, many developments are carried out on the synthetic jet actuators. One of the objectives of SFWA-ITD is to increase Technology Readiness Level of this kind of devices. Onera is involved in this work and develops actuators which could be integrated and tested in wind tunnel models for both SFWA-ITD and GRC-ITD projects.



Figure 20 - GRC helicopter fuselage in the Onera L1 wind tunnel (left) and detailed view of the rear fuselage equipped with actuators (right)

Within GRC-ITD project, it was asked to integrate eight synthetic jets in the fuselage of a helicopter's wind tunnel model (figure 20 and [25] for the results). The specifications are the following ones:

- orifice shape: slots with dimensions $0.67\text{mm}\times 30\text{mm}$;
- blowing angle: 45° with respect to local wall tangent;
- Peak velocity: $80 \text{ m}\cdot\text{s}^{-1}$;
- Frequency bandwidth: 200 Hz.

The object of the study was to propose an actuator for which the speed of jets remains relatively constant on a large frequency

bandwidth and for which it is possible to modify speed for a given frequency.

Comparison with state of the art

Many studies are dealing with synthetic jets devices. There are 2 main developments which are the subject of patents or publications.

The first one is the generators of synthetic jets operating piezoelectric technologies via the use of membrane type actuators, as it is the case for the following patents: US 2010/0044459A1, US 2010/0045752A1, US 2010/0043900A1, US 2008/0197208A1, US 2008/0087771A1. Contrary to these devices, the solution described in this paper does not imply the deformation of a membrane but the displacement of one (or several) piston(s), increasing the force and stroke available for the compression of the gas in the chamber of ejection. On the other hand, because of the actuator characteristics, the use of the membrane synthetic jets is limited to an optimal frequency generally based on the resonance of the active part and the cavity where is compressed the gas before ejection.

A second development deals with piston technology, as described in [5]. The main difference compared with Onera's design is that this solution is based on the movement of a piston actuated by a crank/rod system which does not allow the adjustment of the piston stroke, and, as a consequence, does not allow the regulation of the jets speed for a given frequency.

Technical solution

Figure 21 shows a picture of one synthetic jet actuator. The synthetic jet comprises a cavity delimited by a fixed wall and a mobile wall. The fixed wall contains a sleeve and a head provided with an orifice through which the fluid is sucked from and expelled to the main flow. The mobile wall is opposite to the head. The actuator comprises a rigid piston which slides into the sleeve.



Figure 21 - One synthetic jet before integration into the model

The synthetic jet is based on a piezoelectric stacks actuator, mechanically linked with the piston and able to drive it with an alternating movement having a variable amplitude and frequency. Once again, since the stroke of the piezoelectric actuators is very short, the system comprises a mechanism for the mechanical amplification of displacements up to 0.6 mm, based on steel joint blade articulations in order to have a significant variation of the cavity volume. The fact that this amplification is not obtained by forcing of the piezoelectric at the natural resonant frequency allows a constant output velocity to be obtained over the entire actuator frequency range.

The solution applied here does not imply the deformation of a membrane, thereby increasing the force and the stroke available for the fluid compression inside the chamber. To modify the output velocity of the synthetic jet, the stroke of the piston is simply varied. The frequency bandwidth of this actuator is approximately 200 Hz.

Figure 22 shows the hot-wire velocity signal at the synthetic jet exit for three voltages at a frequency of 200 Hz. For this measurement, the hot wire is located in front of the slot. As expected, the higher the voltage is, the higher the output velocity is. The maximum output velocity is about 80 m.s⁻¹. The highest peaks correspond to the blowing phase and the lowest ones to the suction phase. Since for a synthetic jet the velocity vector is straight during the blowing phase and the flow coming into the actuator chamber is sucked in from all directions, the hot-wire location slightly above the actuator exit rather into the slot induces a difference in the amplitude of the velocity peaks between blowing and suction.

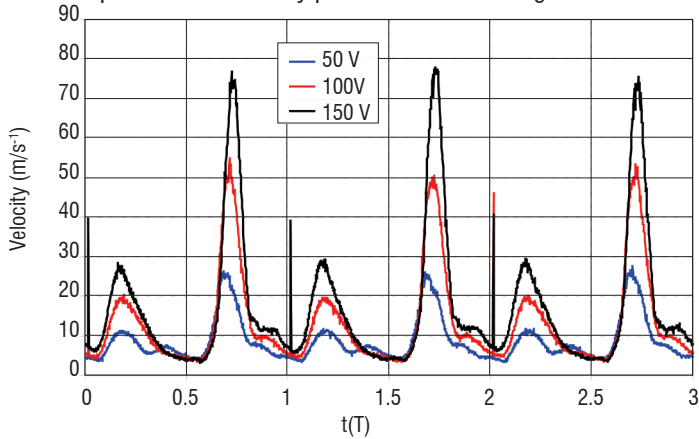

Figure 22 - Hot-wire velocity signal for three voltages at f=200 Hz

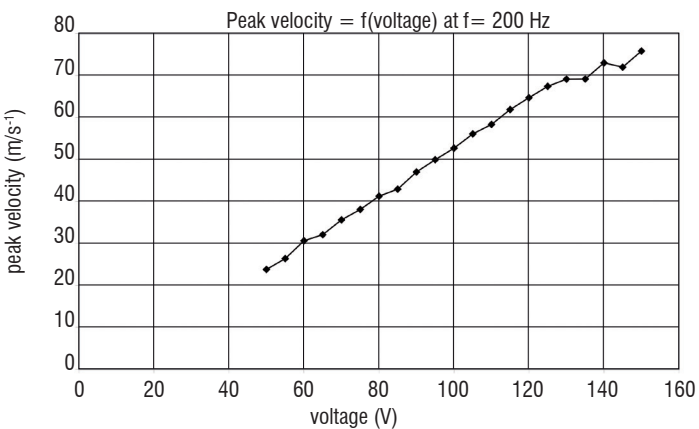

Figure 23 - Peak velocity as a function of voltage at f=200 Hz

The evolution of the peak velocity with the voltage applied to the actuator is plotted in figure 23 for a frequency of 200 Hz. As expected, since the piston stroke evolves linearly with the voltage, the peak velocity also evolves linearly with the voltage, since at the first-order (without viscous and compressibility effects), the peak velocity is given by:

$$U_{peak} = S_{piston} / S_{orifice} \cdot A \cdot \omega \quad (1)$$

where U_{peak} is the peak velocity, S_{piston} is the piston area, $S_{orifice}$ is the exit orifice area, A is the piston half stroke and ω is the pulsation.

The evolution of the peak velocity with the forcing frequency for a constant voltage equal to 150V is shown in figure 24. The peak velocity is nearly constant and equal to 80 m.s⁻¹ between 170 and 240 Hz. Equation (1) shows that the peak velocity should increase

linearly with the frequency but in fact, the rise time of the piston is constant and does not depend on the frequency. This is the reason why the peak velocity is constant between 170 and 240 Hz. In fact, in this case, it is the duty cycle, which varies with the frequency.

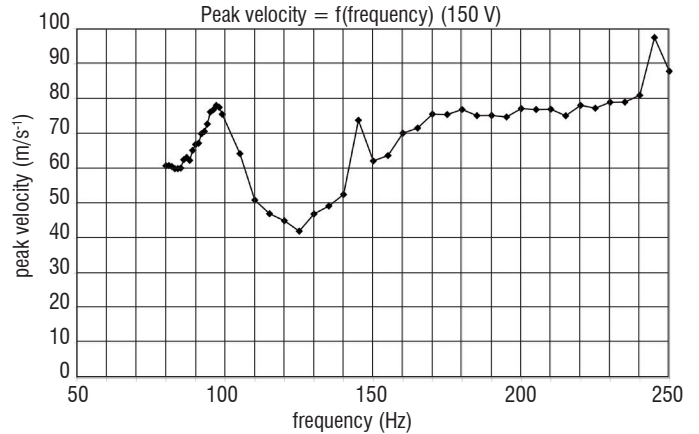

Figure 24 - Peak velocity as function of forcing frequency for 150 V

Actuator command

The input signal takes into account the mechanical behavior of the actuator and allows the piston displacement to be controlled according to the characteristics of the desired output velocity, by using gauge sensors installed on one steel joint blade of the kinematics. The input signal applied to the mechanically amplified piezoelectric actuator makes it possible to control the frequency and amplitude of the actuator. The difficulty with regard to the electric drive of such a device is how to take into account the mechanical response of the system to very short time pulses. To reduce the parasitic phenomena of oscillations, the input signal is adjusted (time-constant and duty cycle) according to the output signal. Sensors installed inside the actuator allow the piston displacement to be controlled by adapting it to the desired output velocity signal.

Application of active flow control at the leading edge

A study was carried out within the JTI Clean Sky Smart Fixed Wing Aircraft Integrated Technology Demonstrator (SFWA-ITD) European project, in order to evaluate the compatibility of this technology with the leading edge of a wing in a large scale model.

The outcome is a representative prototype equipped with a large scale synthetic jet actuator that blows through a tangential slot with a width of 0.2 mm and a span of 145 mm, located at 1% of the local chord (figure 25). In this configuration, the actuator is able to generate a jet whose velocity is equal to 110 m.s⁻¹ [± 10 m.s⁻¹] for a frequency range of [50 Hz; 200 Hz] (figure 26).

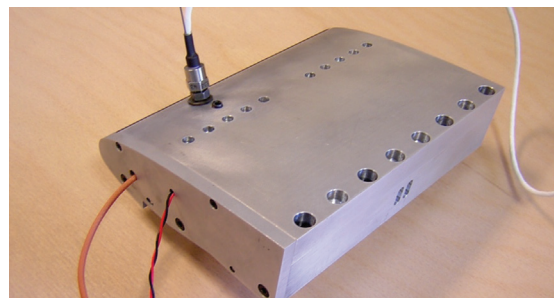

Figure 25 - Picture of synthetic jet actuator in a part representative of a large scale wing leading edge

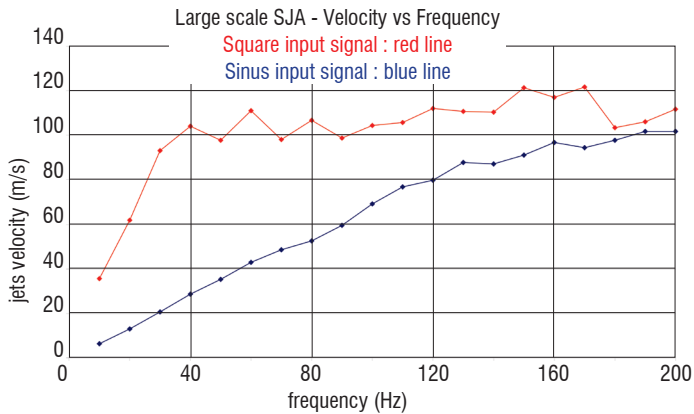

Figure 26 - Large scale SJA characterisation

Fluidic actuator characterization

The detailed knowledge of the performance of a fluidic actuator is a decisive input for its design and manufacturing process. The qualification of such an actuator is required, not only during the prototype optimization steps, but also for its reception as an isolated component of a wind tunnel model (figure 27) and once integrated into the model (figure 28). The qualification concerns all kinds of fluidic devices: continuous, pulsed and synthetic jets.

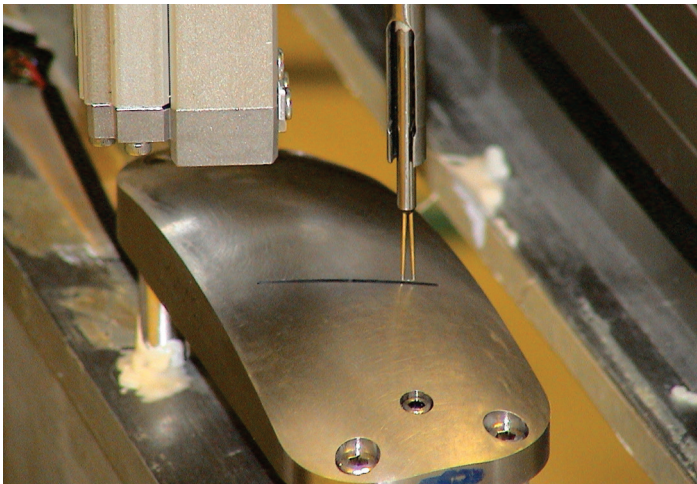

Figure 27 - Hot-wire qualification of an actuator as a wind tunnel model component

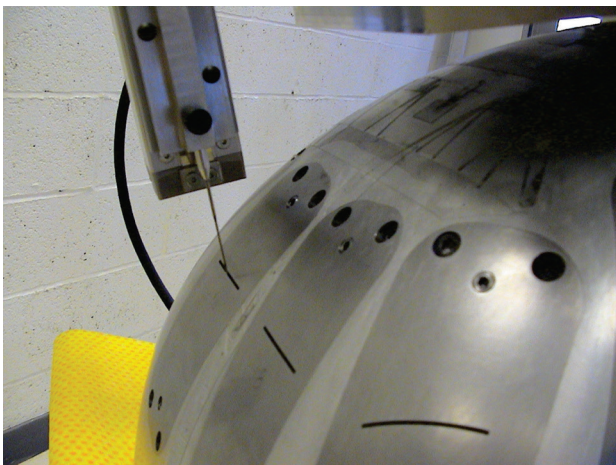

Figure 28 - Actuator qualification once integrated into the helicopter fuselage model

The objective of the qualification operations (referred to as “characterization”) is to measure the performance of the actuator under quiescent air conditions, or exceptionally in interaction with an academic incoming flow, typically a turbulent boundary layer. Most often, the characterisation is performed on a specific bench, in quiet air. Thus, the characterisation does not necessarily allow the identification of the actuator behavior under actual working conditions (wind tunnel tests once integrated in the model or flight conditions), which can be different from quiescent air conditions. However, it yields inputs for set parameters, such as input voltage or pressure, type of input signal shape, etc.

Generally, the characterisation consists first in determining the operational frequency domain in which the jet accurately responds to the desired input signal. Second, it consists in measuring the jet velocities (peaks or even entire shape of the velocity profile) in the operational frequency domain. Sometimes, it may include the assessment of the homogeneity of the exit velocities.

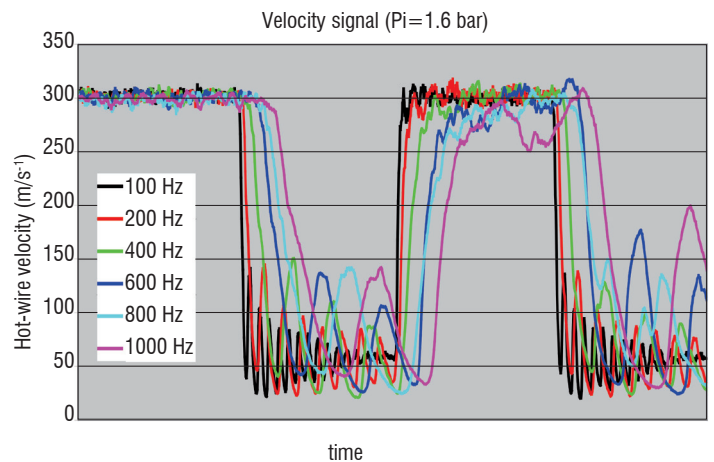

Figure 29 - Pulsed jet velocity obtained from hot-wire measurement with a square shaped input electrical signal – Specific in-situ calibration has been applied to HW before the measurement in order to catch an estimate of the instantaneous velocity (here 300 m.s⁻¹)

In practice, the excitation frequency ranges from ten hertz to one kilohertz and the jet velocity level can be low (incompressible flow) or high (supersonic compressible flow). For such conditions, the Hot-Wire Anemometry (HWA) is the preferred measurement technique: it is particularly well suited to derive (or at least get a good estimate of) the instantaneous velocity, or to identify velocity signal shapes (figure 29). For the latter, the velocity signal can be compared to other signals, such as electrical input, location of the moving component of the actuator or internal cavity unsteady pressure; this allows the transfer function, including amplitude and phase shift, to be derived. According to the results, the actuator will be (or not be) improved.

A key factor for the HWA is the calibration procedure. As a matter of fact, for most of the actuators, the classical calibration procedure in a calibrated, uniform flow does not apply. This is due to the diameter of the jet to be measured, which is of the order of magnitude of the hot wire length (figure 30). In such a case, the hot-wire active sensor sees the strong transverse gradient jet velocity profile, and is not uniformly cooled.

In order to take into account the jet velocity profile, a procedure has been developed to calibrate the hot-wire in-situ, i.e., without moving

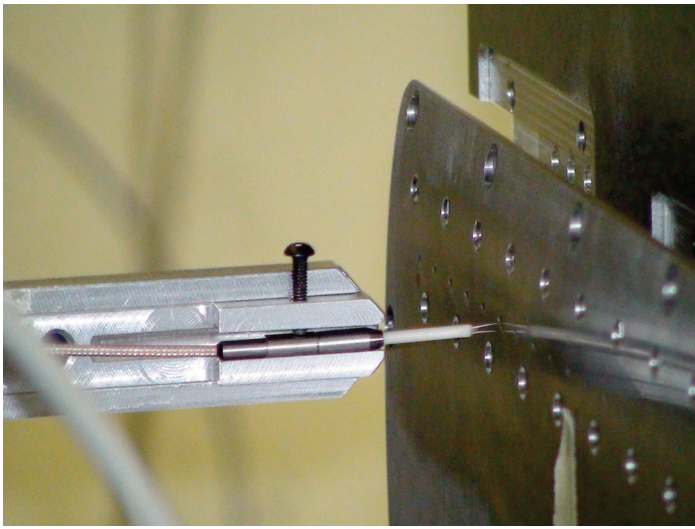

Figure 30 - Hot-wire in front of a supersonic jet actuator exit (here, a nozzle)

the sensor for its calibration. This allows the hot wire to be calibrated with respect to well-known upstream conditions, either the total pressure of the air supply or the mass flow measured in the air supply circuit. In both cases, a theoretical velocity in the actuator exit section can be derived and thus, the relation between this theoretical velocity and the hot wire tension can be established for a range of upstream conditions. This procedure can directly be applied to continuous and pulsed jets, which require a pressurized air supply.

However, its application to synthetic jets is more challenging. For such devices, the notion of upstream conditions does not apply. In order to get such conditions, the actuation mechanism is temporarily replaced by a substitution nozzle, without any active mechanism, but with an upstream connection to the air supply. Once the relation between the hot-wire signal and the theoretical velocity has been established, the actuation mechanism of the synthetic jet is mounted again and its characterisation can be performed. Of course, this methodology is time consuming and delicate, especially when several actuators must be qualified simultaneously. Indeed, each new hot wire positioning requires a new specific calibration.

If the characterization of the velocity signal shape is not required, another method can be used for pulsed jets. The pulsed air can be collected at the actuator exit with an airtight bell (red circle in figure 31). Then, it is brought to a mass flow meter located downstream. This measures the average mass flow of the pulsed jet (figure 32).

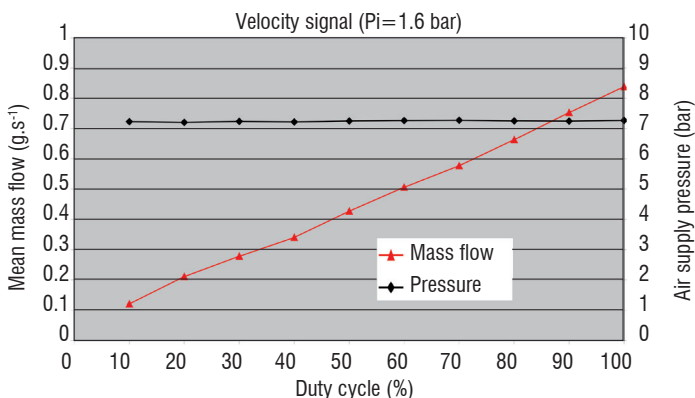

Figure 32 - Mean mass flow obtained with the bell method with respect to the duty cycle (square input signal)

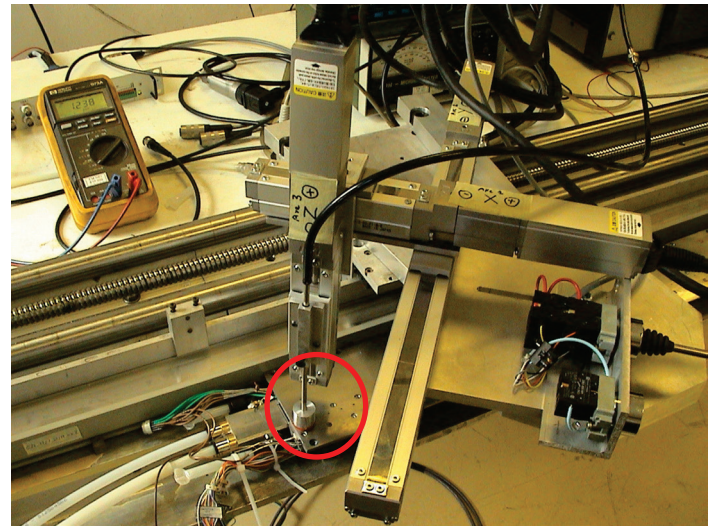

Figure 31 - Mass flow qualification of pulsed jet actuators using a specific air tight bell



Figure 33 - In-situ hot-wire probing of a fluidic trailing edge device (TED). The probe is mounted on a high accuracy, motorized robot with 3 degrees of freedom

For cases where the hot wire length is much smaller than the jet exit section (limit arbitrarily fixed at 2 mm in next table), a classical calibration procedure can be used. A typical case is the high aspect ratio slot, for which the hot-wire can be moved in the slotwise direction. The velocity jet profile can be reconstructed from instantaneous measurements at different locations, using high accuracy robots and off-line post processing tools (figure 33 and figure 34).

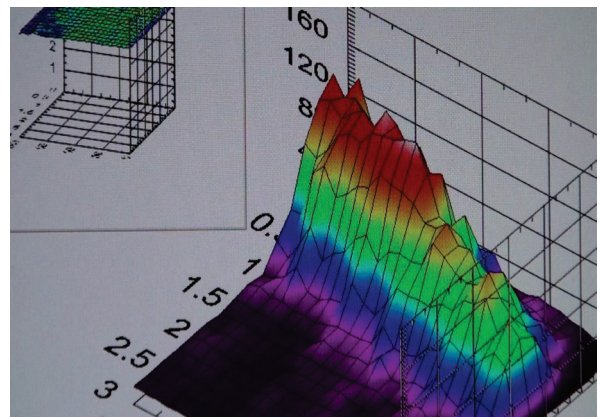

Figure 34 - Example of an instantaneous velocity profile at a slot exit (pulsed blowing TED)

Equipment	Actuator type→ Jet exit size→ Measured data ↓	Pulsed		Synthetic	
		Lower than 2 mm	Longer than 2 mm	Lower than 2 mm	Longer than 2 mm
Hot wire anemometry $f_{max} > 40$ kHz					
Classical calibration	Instantaneous velocity, subsonic	no	yes	no	yes
In-situ calibration, from upstream total pressure and density	Max. instantaneous velocity, subsonic	yes	No interest	Substitution tip with air supply	No interest
In-situ calibration, from mass flow meter and density					
In-situ calibration, from airtight bell	Mean mass flow, sub- sonic and supersonic	yes	yes	homogeneity	homogeneity
Optical metrology					
LDV, max. frequency depending on the seeding quality	Instantaneous velocity of particles	yes	yes	yes	yes
PIV, fixed frequency	2D maps of instanta- neous velocities	Depends on spatial resolution	yes	Depends on spatial resolution	yes

Table 1 - Summary of available methods for actuator qualifications

In addition, as an example of actuator qualification in an academic flow, a synthetic jet in a turbulent boundary layer has been studied in a boundary layer wind tunnel. In this case, the actuator exit was 0.5 mm wide and 30 mm long. The hot wire probe was located at 0.2 mm inside the slot. Similar results were obtained with the wind tunnel off and on (with and without wind) (not shown here). The velocity of the wind tunnel was fixed at 30 m.s⁻¹ and the actuator frequency at 200 Hz.

The various methods used for the actuator characterization are summarized in the following table. Although hot-wire anemometry has been used for most of the qualifications carried out up to now, optical methods like L.D.V. (Laser Doppler Velocity) or P.I.V. (Particle Velocity Imagery) are being considered and could bring significant improvements in a near future, since they are not intrusive. However, they require the seeding of the jet, which proves to be difficult, especially for high pressure upstream conditions. Temperature measurements to evaluate either generated momentum or flow rate should be also investigated in the future.

Conclusion and perspectives

Recent progress in the field of micro mechanics and micro sensors has made it possible to develop innovating flow control devices fulfilling the highly demanding specifications from aerodynamic engineers. The very ambitious wind tunnel tests performed using the actuators described in this article were carried out successfully and allow the accuracy of CFD codes developed by Onera to simulate this kind of devices to be assessed.

Since they are either mechanical or fluidic, the actuators developed have been designed to fulfill customer requirements. Moreover, in the case of fluidic actuators, these studies led to the development of specific measurement techniques dedicated to the characterization of micro jets.

Today, Onera still continues its efforts in actuator development, in order to be able to propose technical solutions for the upcoming studies. Thus, new mechanical actuators based on MEMS technologies are studied, with the purpose of making this kind of technology compatible with applications on wind tunnel models. Such solutions allow the flow control application to be considered as a tool for improving the quality of measurements made during wind tunnel tests, or for increasing the accuracy of numerical simulations with active flow control.

Regarding the fluidic actuators, not only within the framework of JTI Cleansky, but also in Onera self-funded projects, work is carried out to improve the performance, not only of the synthetic jets, but also of the pulsed jet actuators. For the latter, the final objective is today the application of these technologies at a larger scale to prepare flight tests.

To characterize such actuators, Onera explores new measurement methods, based on new micro sensors integrated into the mechanical actuators, or new velocity measurement techniques for fluidic actuators.

The actuator characterization benches adapt gradually to the requirements from the experimentalists, who require more and more information with an always greater precision ■

Acknowledgements

The studies performed on the remotely controlled aileron were conducted within the framework of a national program supported by French government agencies (DGAC – French Ministry of Transportation / DGA – French Ministry of Defense) in collaboration with Airbus and Dassault Aviation. The authors gratefully acknowledge Jean-Luc Hantrais-Gervois and Marc Deschamps.

The data related to TEDs actuator had been produced by the AWIATOR Consortium under the European Commission supported project G4RD-CT-2002-00836. The authors gratefully acknowledge Eric Coustols and Daniel Caruana.

Projects SIMCOS and BUFFET'N CO were conducted using Onera's own funding. The authors gratefully acknowledge Arnaud Le Pape, Eric Coustols, Jean-Bernard Dor, Emmanuel Eglinger, Arnaud Lepage and Jean-Marc Massonat.

The work related to the scaled 1 pulsed jet actuator, the synthetic jet actuator and the fluidic actuator characterization has been undertaken within the Joint Technology Initiative "JTI CleanSky", Smart Fixed Wing Aircraft Integrated Technology Demonstrator "SFWA-ITD" project (Contract N° CSJU-GAM-SFWA-2008-001) financed by the 7th Framework program of the European Commission. This research work has been supported by CISIT, the International Campus on Safety and Intermodality in Transportation (www.cisit.org), the Nord Pas-de-Calais Region, the European Community and the Regional Delegation for Research and Technology. The authors gratefully acknowledge Eric Coustols, Annabelle Choffat, Jean-Luc De Coninck, Arnaud Le Pape, Christophe Verbeke and Bruno Mialon.

References

- [1] R.PETZ, W. NITSCHKE - *Active Separation Control on the Flap of a Two-Dimensional Generic High-Lift Configuration*. J. Aircraft, vol. 44, no. 3, pp. 865-874, 2007.
- [2] A.GLEZER, M. AMITAY - *Synthetic Jets*. Annu. Rev. Fluid Mech., vol. 34, pp. 503-529, 2002.
- [3] T.C. CORKE, C.L. ENLOE, S.P. WILKINSON - *Dielectric Barrier Discharge Plasma Actuators for Flow Control*. Annu. Rev. Fluid Mech, vol. 42, pp. 505-29, 2010.
- [4] E. MOREAU - *Airflow Control by Non-Thermal Plasma Actuators*. J. Phys. D Appl. Phys., vol. 40, pp. 605-636, 2007.
- [5] T.M. CRITTENDEN, S. RAGHU - *Combustion Powered Actuator with Integrated High Frequency Oscillator*. Int. J. Flow Control, vol. 1, pp. 87-97, 2009.
- [6] B. CYBYK, K. GROSSMAN, J. WILKERSON - *Performance Characteristics of the Sparkjet Flow Control Actuator*. AIAA Paper 2004-2131, 2nd AIAA Flow Control Conf., Portland, 2004.
- [7] V. NARAYANASWAMY, L.L. RAJA, N.T. CLEMENS - *Characterization of a High-Frequency Pulsed-Plasma Jet Actuator for Supersonic Flow Control*. AIAA J., vol. 48, pp. 297-305, 2010.
- [8] A. BELINGER, P. HARDY, P. BARRICAU, J.P. CAMBRONNE, D. CARUANA - *Influence of the Energy Dissipation Rate in the Discharge of a Plasma Synthetic Jet Actuator*. J. Phys. D: Appl. Phys., vol. 44, 2011.
- [9] L. CATTAFESTA, S. GARG, M. CHOUDHARI, F. LI - *Active Control of Flow-Induced Cavity Resonance*. AIAA Paper 1997-1804, 28th AIAA Fluid Dyn. Conf., Snowmass, 1997.
- [10] A. SEIFERT, S. ELIAHU, D. GREENBLATT, I.J. WYGNANSKI - *Use of Piezoelectric Actuators for Airfoil Separation Control*. AIAA J., vol. 36, pp. 1535-1537, 1998.
- [11] J.M. WILTSE, A. GLEZER - *Manipulation of Free Shear Flows Using Piezoelectric Actuators*. J. Fluid Mech., vol. 249, pp. 261-285, 1993.
- [12] J. KASTNER, M. SAMIMY - *Development and Characterization of Hartmann Tube Fluidic Actuators for Highspeed Flow Control*. AIAA J., vol. 40, pp. 1926-1934, 2002.
- [13] M.J. STANEK, R. SINHA, J. SEINER, B. PIERCE, M. JONES - *High Frequency Flow Control—Suppression of Aero-Optics in Tactical Directed Energy Beam Propagation and the Birth of a New Model (Part I)*. AIAA Paper 2002-2272, 8th AIAA/CEAS Aeroacoust. Conf., Breckenridge, 2002.
- [14] M.J. STANEK, G. RAMAN, J.A. ROSS, J. ODEDRA, J. PETO, et al. - *High Frequency Acoustic Suppression - the Role of Mass Flow, the Notion of Superposition, and the Role of Inviscid Instability - a New Model (Part II)*. AIAA Paper 2002-2404, 8th AIAA/CEAS Aeroacoust. Conf., Breckenridge, 2002.
- [15] G. RAMAN, S. KHANAFSEH, A.B. CAIN, F. KERCHEN - *Development of High Bandwidth Powered Resonance Tube Actuators with Feedback Control*. J. Sound Vib., vol. 269, pp. 1031-62, 2004.
- [16] R. WOSZIDLO, H. NAWROTH, S. RAGHU, I.J. WYGNANSKI - *Parametric Study of Sweeping Jet Actuators for Separation Control*. AIAA Paper 2010-4247, 5th Flow Control Conference, Chicago, 2010.
- [17] L.N. CATTAFESTA, M. SHEPLAK - *Actuators for Active Flow Control*. Annu. Rev. Fluid Mech., vol. 43, pp. 247-272, 2011.
- [18] L. CATTAFESTA, M. SHEPLAK - *Actuators and Sensors*. Chapter 6 in "Fundamentals and Applications of Modern Flow Control", Miller D.N. and Joslin D. ed., Progress in Astronautics and Aeronautics, vol. 231, American Institute of Aeronautics and Astronautics, 2009.
- [19] J.L. HANTRAIS-GERVOIS, A. LEPAGE, F. TERNOY, G. CARRAZ, G. JEANFAIVRE - *Assessment of Numerical Tools to Predict Control Surface Effectiveness*. AIAA Paper 2010-4816, 28th AIAA Applied Aerodynamics conference, Chicago, 2010.
- [20] H. HANSEN - *Application of Mini-Trailing-Edge Devices in the AWIATOR Project*. ODAS Conference, Toulouse, June 2003.
- [21] A.LE PAPE, M. COSTES, G. JOUBERT, F. DAVID, J.M. DELUC - *Dynamic Stall Control Using Deployable Leading-Edge Vortex Generators*. AIAA journal, vol. 50, no. 10, 2012.
- [22] G. JOUBERT, A. LE PAPE, B. HEINE, S. HUBERSON - *Vortical Interactions Behind a Deployable Vortex Generator for Airfoil Static Stall Control*. AIAA Journal, Vol.51, n°1, pp240-252, January 2013, DOI: 10.2514/1.J051767
- [23] E. COUSTOLS, V. BRUNET, R. BUR, D.CARUANA, D. SIPP - *BUFFET'N Co: A Joint Onera Research Project devoted to Buffet Control on a Transonic 3D Wing using a Closed-Loop Approach*. CEAS/KATNET II Conference, Bremen, May 2009.
- [24] J. DANDOIS, P. MOLTON, A. LEPAGE, A. GEERAERT, V. BRUNET, J.B. DOR, E. COUSTOLS - *Buffet Characterisation and Control for Turbulent Wings*. Aerospace Lab Issue 6, June 2013.
- [25] C. LIENARD, A. LE PAPE, C. VERBEKE - *Numerical and Experimental Investigation of Helicopter Fuselage Drag Reduction Using Active Flow Control*. 68th AHS International Annual Forum, Fort Worth, May 2012.

AUTHORS



Frédéric Ternoy graduated as a mechanical engineer from the Ecole Nationale Supérieure d'Arts et Métiers (ENSAM) in 1999. He joined the Model Design and Manufacture Department of Onera as a design engineer and project manager. Since 2007, he has led this department and is involved in model design, especially dealing with flow control technologies.



Julien Dandois graduated from the Ecole Nationale Supérieure d'Arts et Métiers (ENSAM) in 2003 and received a PhD in Fluid Mechanics from Paris 6 University in 2007. Since that time, he has worked in the Civil Aircraft Unit of the Applied Aerodynamics Department, in the fields of high-lift, separation control, buffet control, closed-loop control and aeroacoustics.



Frédéric David joined the Aeroelasticity and Structural Dynamics Department of Onera in 1983. Since 2011, he has worked as test engineer in the C19 facility of the Wind Tunnel Division.



Marc Pruvost received a DUT in Mechanics in 1975. He joined Onera in 1977 and he has been an engineer in the field of industry support since 1996. Since 2005, he has work on the characterization of the fluidic actuators developed at Onera, for which he has developed a test bench.